

Aufbauanleitung / Assembly instruction Xi Grand

Installation ausschließlich an massiver Holz- oder Betonwand möglich. Das beigelegte Befestigungsset eignet sich nur für die Montage an einer Betonwand.

Für die korrekte Befestigung haftet der Kunde. Maximale Belastung pro Regaleinheit 100 kg.

Installation only on concrete wall. The included installation set can only be used for a concrete wall.

For correct installation the customer is responsible. Maximum load weight per unit 100 kg.

1.

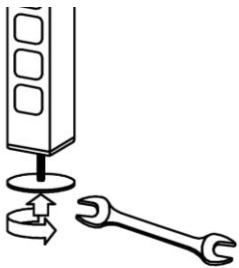

3.

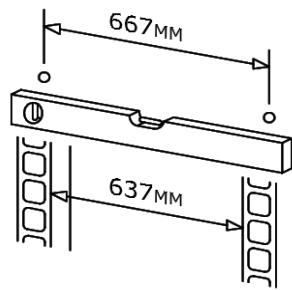

6.

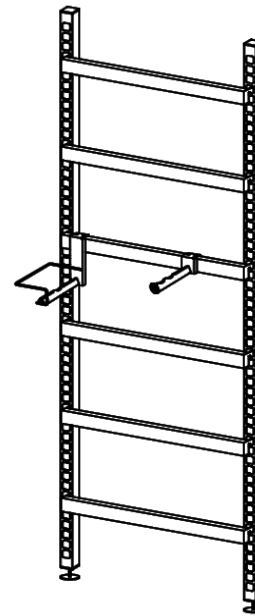

8.

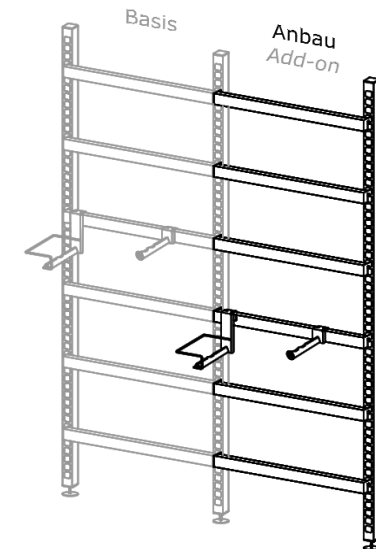

2.

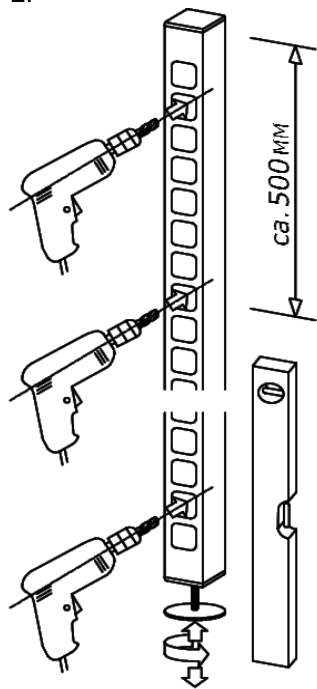

4.

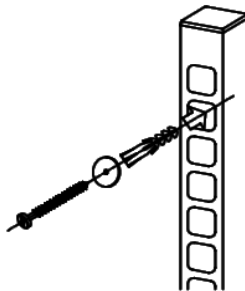

5.

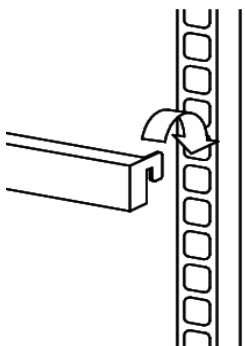

7. Montage Anbau (optional)
Installation Add-On (optional)

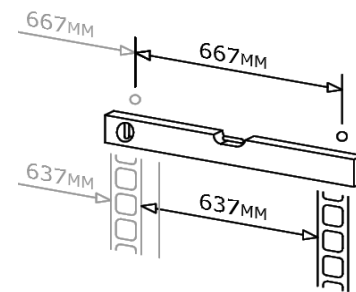

COVINI GMBH

Xi Wine systems pat. reg. ♦ Am Neuner 45 ♦ A-6890 Lustenau ♦ T +43 664 2317575 ♦ office@xi-system.com ♦ www.xi-system.com

UID ATU59699213 / DE265020277 ♦ Firmenbuchnr: 71800p ♦ Landesgericht Feldkirch ♦ IBAN: AT23 5800 0146 1549 8026 ♦ BIC: HYPVAT2B